

21

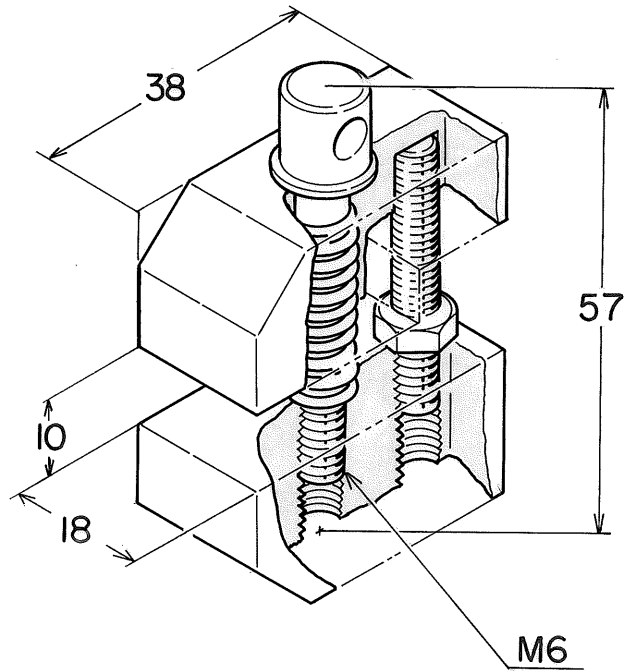

0.5